

# SPRAT No 1

DEVOTED TO LOW POWER  
RADIO COMMUNICATION

G - QRP - C

Rev.G.C Dobbs (G3RJV) 61 Park Street, Cleethorpes. South Humberside.

Following the recent comments in various Amateur Radio journals about the formation of a UK QRP CLUB - this humble little newsletter now appears as an introduction to such an organisation.

It appears thanks to the gift of a stack of paper (quarto is dying) and the loan of a spirit duplicator. Please excuse it's limitations, but I hope it is the pilot edition of a more splendid newsletter to come.

During the last two months many old and new operators have written to me - often at great length - praising the virtues of QRP and giving many useful ideas for the formation of a club. In this newsletter, I have attempted to correlate these views in the hope that a club may be formed tailored to the needs of it's members.

As a group, QRP operators have a lot to offer each other. I trust that intending members are keen enough to see us 'off the ground'. This will mean participation, and some money (!) but more of that later. Many QRP operators build their own gear, experiment with Aerials and are skilled operators on the bands. There is a lot to be shared - future newsletters and sheets can help. So please send me anything which may be of use to fellow QRP op's. News, Logs, Hints, Technical ideas and circuits - just a quick circuit diagram or a few rough notes will do.

Also spread news about the club, amongst locals, during QSO's etc. With a bit of effort, we could have a worthwhile venture on our hands.

LETS GET QRL!

73's **George**  
G3RJV.

\*\*\*\*\*  
CONTENTS:-

Introducing the G-QRP-C.

A product Detector for QRP use. by Edgar Janes (G2FWA)

QRP NEWS SECTION.

VFO Netting Circuit. by Dr.G.Bennett (G3DNF)

Low Power SWR Meter. by Rev.G.C.Dobbs (G3RJV)

CLUB NEWS SECTION.

\*\*\*\*\*

# G-QRP-C

INTRODUCING THE G - QRP - C.

In order to receive this meagre publication, you have shown an interest in Low Power Radio Communication. I have been spending several weeks shifting through a stack of letters about a possible QRP club and I wish to proffer the following :-

- 1) The club be called G - QRP - C, this is simple and can be added to other info on your QSL cards.
- 2) Power limitation is a 'thorny point' (no pun!) Many ideas have been offered. I suggest a nominal 5 watts, but with an absolute max. of 10 watts input - this will serve to attract the Top Band specialists. However for true 'elitist QRP' , the lower the power the better.
- 3) The club slogan is to be 'DEVOTED TO LOW POWER RADIO COMMUNICATION'
- 4) The club will produce a newsletter (once a quarter-at first) with the title S.P.R.A.T. - a suggestion from Gordon G3DNF for 'Small Powered Radio Amateur Transmission', with other connotations!
- 5) The SPRAT will include technical articles, QRP news, Information on skeds/nets, general useful information etc. - all contributed by the members.
- 6) In addition to SPRAT, I hope to be able to send out "QRP BRIEFS" (not little undies\$\$\$) These will be single or double sheets sent out more frequently than SPRAT, giving details of available QRP information which requires a quicker circulation, or perhaps larger technical articles from members etc. If it's important - a QRP BRIEF can soon be sent to all members!
- 7) The club may attempt some sort of annual get together at a central point in the UK - perhaps a convention - perhaps a stand at some other rally - ideas welcome.
- 8) The club will make an annual award thanks to the kind offer of Nick Carter - THE G2NJ QRP TROPHY - See details elsewhere in this publication. The cup will be held for one year, but the winner will retain a smaller trophy.
- 9) The club will battle for the rights of QRP operators, especially in the areas of the ever-eroded CW end of the L.F. bands.
- 10) I hope that the club will attempt to attract young licenced and would-be licenced operators into the world of QRP, with it's advantages of low cost, home built gear, low 'band pollution', CW operating skills and satisfaction.

AND NOW THE DEBIT SIDE !

We will require money, I am happy to help as much as I can, but a general subscription is now essential. I suggest that we all pay in a sum of £1.25 per year for membership. I hope that this will cover all expenses, including SPRAT and postage. I will open a bank account in the name of the club and will submit a balance sheet twice a year.

If you wish to join - this is YOUR club - please send P.O.s or cheques ( made out to QRP CLUB) and send them to my address. Please complete the form below and send to my address

**George G3RJV.**

.....

.....

(This article first appeared in the Cheltenham Group Newsletter, the circuit has been recommended to me by Nick (G2NJ) - G3RJV.)

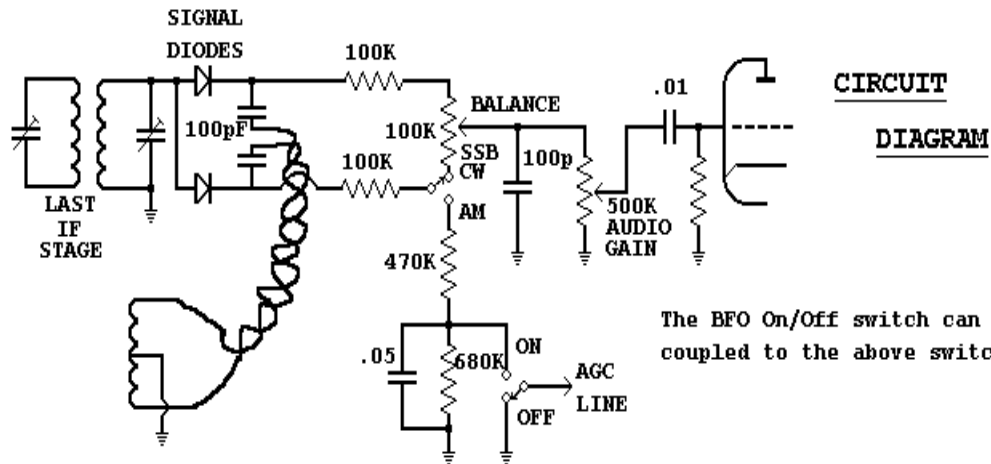

Link on BFO coil  
20 turns of very  
thin wire each side of  
centre tap, scramble wound directly  
over the BFO coil, insulated by a layer of plastic tape.

The product detector is well worth considering if you are keen on CW working, when you wish to pull the weakest signal from the background. Normally when the BFO is switched on the background noise rises, varying in pitch according to the setting of the control. With this circuit the 100K pot is adjusted for balance which is indicated by a very deep null in both noise and any amplitude modulated signal that manages to get through, when the circuit is unbalanced. As a bonus, your weak SSB signals are more readable.

I have fitted this to G2NJ's HRO and he is amazed how it helps his QRP activities on 40 metres when signals came out of an almost non-existent background. Yes - Even on 40 !

Keep the layout balanced and screen the audio wiring to reduce hum pickup to a minimum. The signal diodes ( 1N914 / 1N4148 types are very suitable) must be matched with a high back resistance. This is probably a good case for using a pair of hot carrier diodes.

Like the Pear's soap advert - Try this once and you will use no other !

\*\*\*\*\*

HW-7 OWNERS

I have a photocopy of the QST Jan. 1974 articles, HW-7 QRP TRANSCEIVER MODIFICATIONS by W1CER. Members may have a 'photocopy of the photocopy' by sending me a S.A.E.

I also have a copy of the MFJ Filter circuit - about which, the above also applies. I am in the process of building a version of the filter on Veroboard using Radio Spares Op Amps. Hopefully ! I may give full details of the project (if it works) in the next newsletter.

George.

QRP NEWS....QRP NEWS....QRP NEWS....QRP NEWS....

My heavy correspondance has at least proved that QRP op's are a friendly lot. I hope that members of the club will continue to write to me - got anything to say, then let me know, we have a lot to share.

G5BIU/WASTLQ/O1AX is now in the Scilly Isles, going great guns with his HW-7. David has other gear to arrive from the States and I hope that he will continue to join in the club action while he is in the UK. David has already worked 30 countries with the HW-7 (+ CWF filter and R.I.T.) for his new QTH. He points out that although the power limit of the Stateside QRP ARC is 100w. the 'MILLIWATT' QRP journal is devoted to QRPP ie. under 5 watts.

G8PG (Gus) has reminded me of the twice a year DL QRP CONTEST. The winter contest is 11-12 Jan '75. Details from Gus. Gus also points out the QRP DX TESTS. These will take place in Feb and March 1975 each Saturday and Sunday. Times 1130-1230 & 1600-1700 GMT. Freqs 14060 to 14065. DX stations call CQ for 1st five mins, EU stations during 2nd five mins. and so on. UK logs of QSO's and stations heard to Gus. QTHR.

WB8OWM. 'Skip' Westrich in Canton, Ohio, is our first possible Stateside member. Skip uses a HT-18 (2½ watts) and an HW-7 into an ATU to 66' end-fed. I hope to hear more from Skip about QRP in the States.

G2BS.up in Tyneside is not only our oldest call, but so far our most northern station. Where are the QRP GM's? '2BS runs an HW-7 and has home construction plans with the Plessy SL600 series - Keep us informed.

G3CED/G3VFA George Partridge - the 'joystick man' has written a couple of interesting letters about his QRP activities using an indoor Joystick VFA and a PM2 on 1 watt. George's results (hope for more details from him later) show that good results come from a VFA and QRP on 80 and 40 !

G3DNF Gordon, a well-known QRP op (see his article in this newsletter) tells me that the RSARS has a new QRP certificate for members (NO details as yet) Gordon has certificate 002 and G2HKU, another of my corresponders obtained 001. Gordon has promised some more technical articles based on some of his QRP home construction work.

GI2DZG.Walter in Belfast, kindly wrote a good article for this newsletter sadly, because the duplicator is only suitable for one-sided copying, I am short of space but Walter's article will come into print in the next (I hope) more splendid edition of SPRAT.

G3ANQ. 'Ted' in Wimbledon, wrote offering a hearty support for the club. He calls QRP 'the very stuff of amateur radio', and calls for effort to defend the LF ends of 160 and 80. Ted describes some interesting QRP 'antics' with himself and G3EJN, in beating QRO signals on 80. I would like to see a fuller article or notes by Ted on this theme.

G4AYS. I have one rather short note from this intrepid QRP operator! After reading of his operation via G2NJ, I hope he will give us some more details of his work, and hopefully his gear.

MANY THANKS TO ALL who have written to me. I can't include all the interesting remarks in this rather scanty newsletter. Please keep writing, without members contributions, a newsletter is impossible.

CIRCUIT  
DIAGRAM

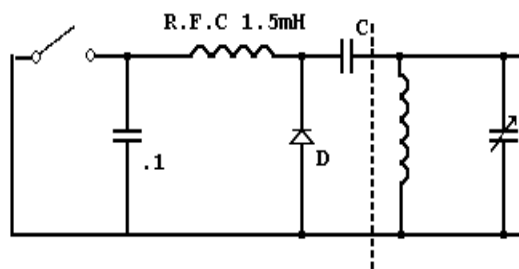

This is a circuit which I have found useful in QRP rigs, although it could be applied to most VFO's.

In a simple 'straight through' QRP TX, the VFO must be detuned or switched off during receive, unless it forms part of a direct conversion RX. Switching off the VFO usually results in drift when it is turned on again. Detuning does not have this disadvantage, but it is essential to ensure that the transmitting frequency can be accurately reset. This circuit is related to a detuning circuit often used for RIT control on transceivers.

The switch is closed during transmit and netting, when a capacitor (C) in series with a varicap diode (D) forms part of the VFO tuned circuit. The value of C is small, so that the diode does not load the tuned circuit to any appreciable extent.

On receive, the switch is opened. A small reverse DC potential then appears across D, due to the rectification of the RF passed by C. The resulting capacitance of D in series with C is less than that of C with the diode shorted to DC. As a result the VFO frequency shifts upwards a few kHz, outside the receive passband.

The value of C is usually a few pF (polystyrene or s/mica) which should be sufficient to produce the desired effect. The size of the varicap used will also have some influence on the choice of capacitance. Polarity of the diode is not important.

All components except the switch should be securely mounted in the VFO box. The switch can be part of the transmit/receive switch or relay. A separate toggle switch, wired in parallel, will give a netting facility.

\*\*\*\*\*  
CRYSTALS - CRYSTALS - CRYSTALS .....

Perhaps, like me you have found 80m xtals hard to come by? The other day I called at J. Birkett's shop in Lincoln and found a box of mixed rocks at 15p each. I sorted out several at 3550 & 3548. He has several of the ones at 3550 left. George, his assistant, agreed to sort some out for people who write or ring (Lincoln 20767) - mention my name. Please send some P&P.

John is an old friend of mine from my days at my Lincoln QTH (I baptised his first daughter!) and if you are passing Lincoln, the shop is well worth a visit. It's like Lisle Street of yester-year ! ADDRESS:- J Birkett, The Strait, Lincoln LI2 1JF.

Could this become a useful QRP net frequency?

BOOK REVIEW: by G3RJV

"SOLID-STATE Q.R.P. PROJECTS. By Edward M. Noll W3FQJ

This is a rather old publication (1970) which came to my sight at the Leicester Show. It is obtainable, by post, from the States through HAM RADIO magazine.

Although basically practical in nature, this book does have an opening chapter of introduction to the techniques of Solid-State QRP construction. This is a reasonable introduction for would-be home-brewers. A later section describes the use of some commercial QRP modules and PCB's. These include the Ten-Tec Modules ( which I have not seen for sale in the UK) and a couple of useful PCB modules called ICM (International Crystal Manufacturing). From looking at these, in photo and circuit form, I realise that they are the same as a couple of the kits now available in the UK under the name AMTRON (a guess at the spelling, haven't got catalogue to hand) Catalogues for this range can be obtained from J.BIRKETT at Lincoln.

The rest of the book is devoted to practical projects. Most of these are in module-form ie. Xtal and V.F.O's, R.F. Amplifiers, Modulators, Sideband Generators etc. The individual units can be combined to produce complete transmitters and ideas for doing this are given. Although no complete rig is outstanding there are many useful ideas. As usual in American books the problem of components arises - many of the hard to get (for me anyway ?) HEP type transistors are used, and the infamous J.W.Miller Coils.

The final chapter is a mediocre section on antennas for QRP use. One or two ideas, but nothing really new. There are, however a couple of useful bonuses in this book. There is a useful short section on IC's in QRP work, with some ideas which could be modified for use with British types. Then a gem of a little section dealing with the winding of toroids, This gives a useful table for coils using toroids which can be obtained in the UK (See Club News page)

To sum up - a useful little book. If its worth the couple of quid it costs to get it from the States is a question open to debate. But it will provide me with some ideas and perhaps a bit of construction work during the long cold nights.

George.

\*\*\*\*\*

BOOKS AND INFORMATION.....

"Breed any good rooks lately ?"

We are all picking up ideas all the time from books, magazines etc. It may be that we can share them. Naturally ideas in Rad.Com. and S.W.M, etc are generally known, but if you pick up anything useful in other magazines or books eg. QST Ham Radio etc. send them along for sharing. Although I don't want to be brought to court on a copyright charge - I do have access to a photocopier and we can redraw any worthwhile circuits that are not too complex. (Copyright is on ACTUAL WORDS, not ideas)

So send in ideas, your own or secondhand, review a book, review a piece of commercial gear or the results of trying out a published circuit. It may be very useful.

LOW POWER S.W.R. INDICATOR.

By G3RJV.

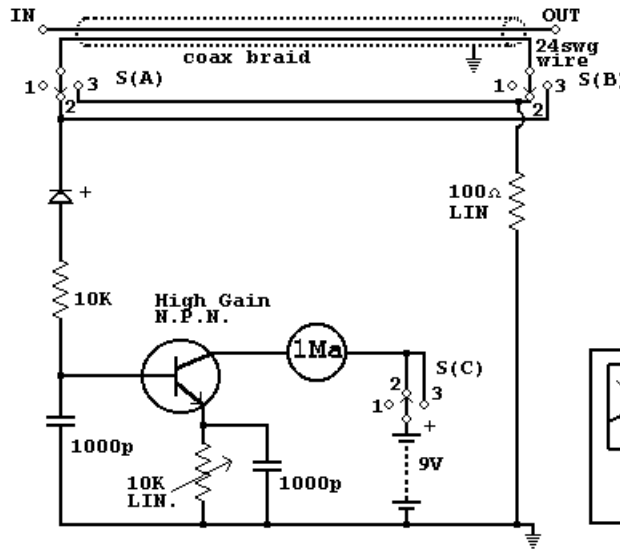

CIRCUIT DIAGRAM.

Switch: 1=off 2=Forward 3=Reverse

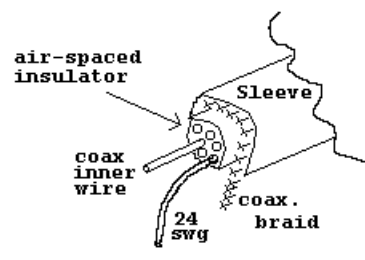

Coax cable arrangement

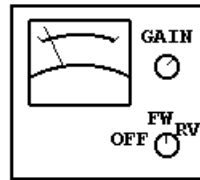

Case front

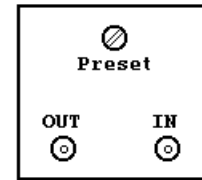

Case rear

This little circuit has been in use at G3RJV for several months and has been very useful in loading the HW-7 rig into various aerials. Naturally it does not beat a correctly calibrated SWR Bridge, but it provides a useful indication of matching - certainly better than the Heath 'Relative Power' meter.

- 1) The bridge is based upon a length (random choice of about 18") of heavy duty AIR-SPACED coax cable. The ends are bared as shown, and a couple of feet of enamelled 24 swg wire is carefully threaded thro' one of the air-spacing holes.
- 2) The three leads from each end must be insulated from each other - I used a mess of PVC tape! The 100Ω pot is preset for reference.
- 3) The Forward and Reverse currents are switched into a simple D.C. NPN amplifier. The gain of the amplifier is controlled by a 10K pot, this is a useful front panel control - increase the gain to show low levels of current flowing in the bridge.
- 4) The switch 4p/3w is used for DC amp. off and Forward and Reverse reading. A PP3 provides the power.
- 5) Construction is not critical. To ensure a decent earthing point, I put a stout bus-bar across the case for a common earthing point. The D.C. amp was built on a tagstrip as below :-

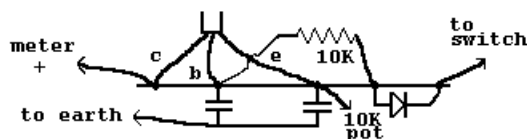

DC AMP. LAYOUT.

- 6) The indicator was set up using a dummy load across the output. The front panel gain control is very useful when reading low reverse currents.
- 7) Two watts input pushes the needle hard over (on forward) with about 1/3 gain, but this naturally depends upon the transistor used and a diode with a low forward resistance.

\*\*\*\*\*

HAVE YOU GOT ANY CONSTRUCTION IDEAS ?

CLUB NEWS + CLUB NEWS + CLUB NEWS + CLUB NEWS:  
THE G2NJ TROPHY.

Nick Carter (G2NJ) a name familiar to most QRP men - (who hasn't worked Nick on 160 or 80?) has kindly offered to present a cup to the QRP CLUB. The trophy will not be yet another contest award, but will be available for anyone working in the realm of QRP. It will be awarded each year to the person who is able to submit evidence of "the best overall contribution to QRP work during the year" This rather loose definition may well be subject to closer terms of reference - but this will be announced. A small Panel will decide the overall winner, who will keep the trophy for a year, and also receive a smaller trophy to keep. The panel will (at the moment) consist of Nick himself, G8PG - the well known QRP man who handles the UK side of the DL QRP Contests, and myself (G3RJV). We hope the award will become highly sought-after amongst qrp op's - More news to follow.

DL QRP CONTESTS & QRP DX TESTS.

See the note under G8PG in the QRP NEWS page. Further details from Gus at 37, Pickerill Rd. Greasby, Wirrel, Merseyside.

SKEDS & NETS.

Many people have suggested skeds/nets on 80m for the club. G3IGX suggests 3505 on Sunday afternoons. Nick (G2NJ) is active on about 3575 (to miss QRM) at midday, most days.

I suggest that perhaps we try the following :-

- 1) Anyone in need of a QRP report on 80, try a sked with Nick - He has a fb. RX using the product detector described in this newsletter, and is glad to listen for, and work, any QRP stations.
- 2) Members who would like a Sunday net on 80, should perhaps try using 3505 at 1600 GMT on Sundays. Please send reports and results to me and we can then see if this idea is workable. So give it a try during Jan. and we can go on from there.
- 3) I am to circulate a list of members, with QTH and interests - so look up who is involved with "your thing" and arrange personal tests and skeds with like-minded members.
- 4) Note the section marked "CRYSTALS" - perhaps 3550 is possible ?  
Any more ideas???

TOROIDS

Many of the fine articles coming out of the States use toroids usually named as "Amidon" - Both recent HW-7 modification articles in the QST use these formers. They are available in the UK through : TMP Electronic Supplies. 3, Bryn Clyd, Leeswood, MOLD. Flintshire. CH7 4HV. An SAE will bring a useful leaflet with winding data.

AD'S & SWAPS.

In the following newsletters, I hope to include a section for members to advertise, for sale or swap, their surplus gear. This will be a free service - Got anything laying useless about the shack?

COPY FOR THE NEWSLETTER.

The newsletter can only be as good as the stuff that goes into it. Material is very welcome - don't be cautious - you don't have to be an author, rough notes will do.

BEST WISHES 'TILL NEXT NEWSLETTER OR Q.S.O

**George**  
G3RJV.